

Sam Noble Museum
THE UNIVERSITY OF OKLAHOMA.

Indoor Boomerang #1: X-Wing

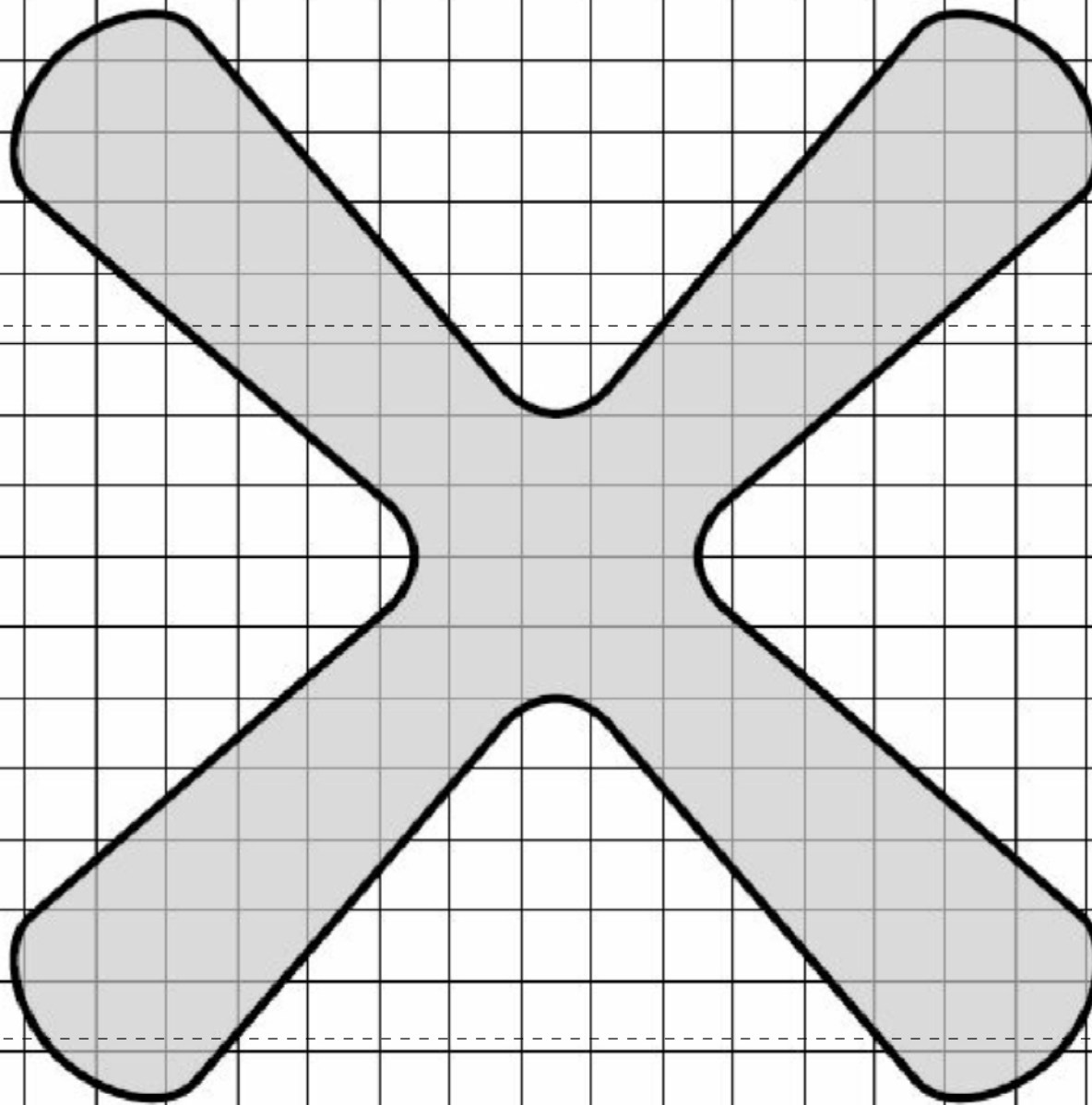

Sam Noble Museum
THE UNIVERSITY OF OKLAHOMA.

Indoor Boomerang #1: X-Wing

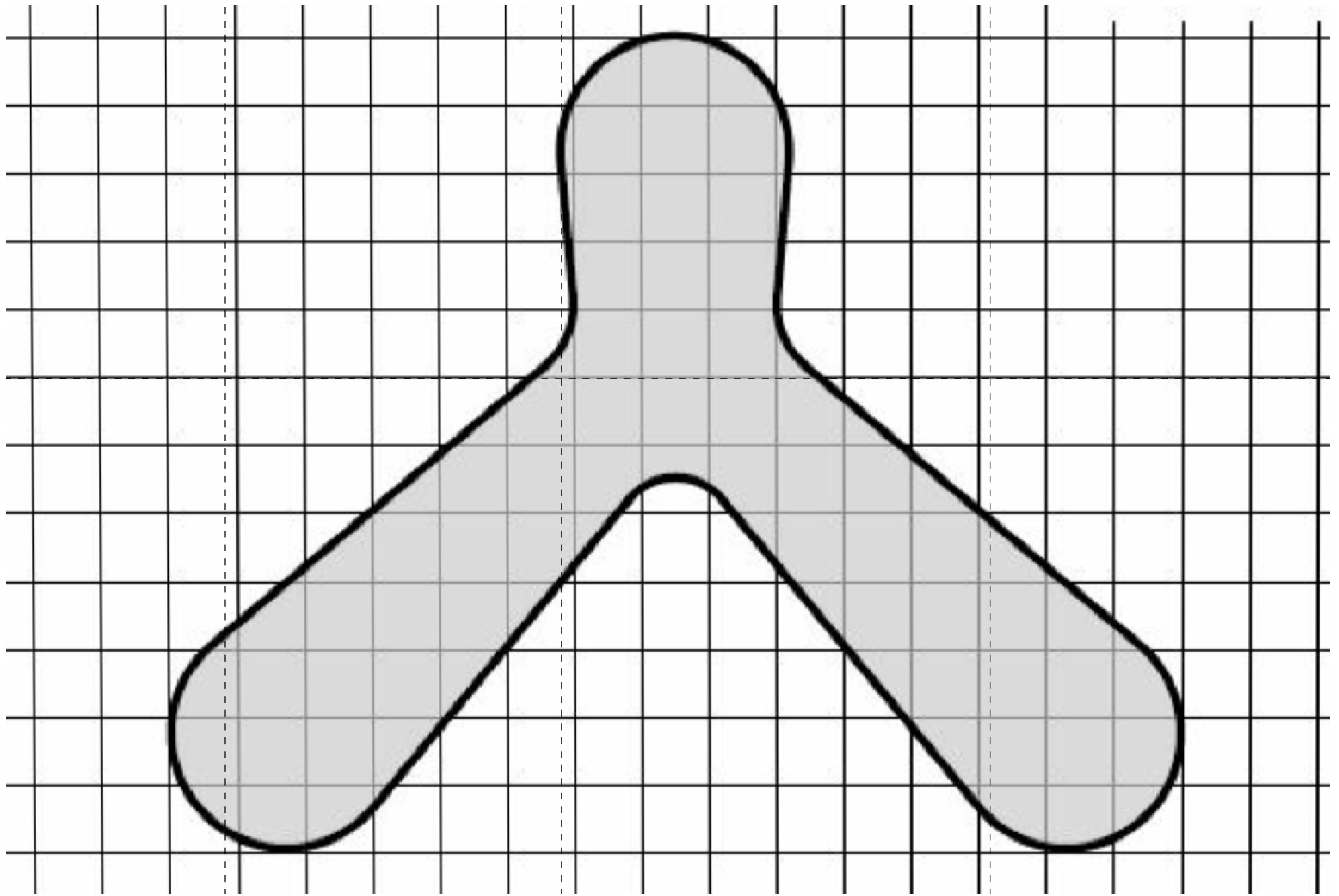

Sam Noble Museum
THE UNIVERSITY OF OKLAHOMA.

Indoor Boomerang #1: X-Wing

Postkarte

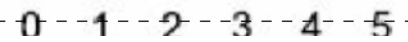
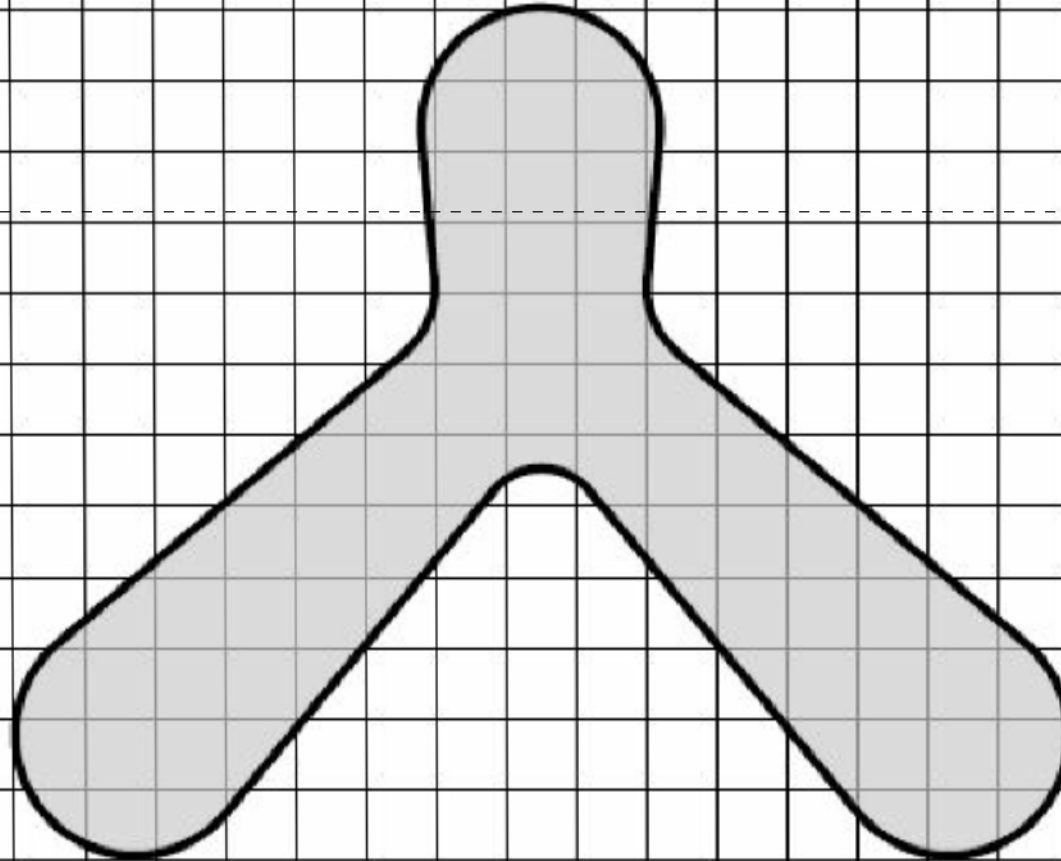
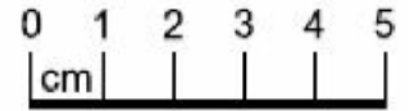

Sam Noble Museum
THE UNIVERSITY OF OKLAHOMA.

Indoor Boomerang #1: X-Wing

This is your pattern.
Use this to make 2 wings.

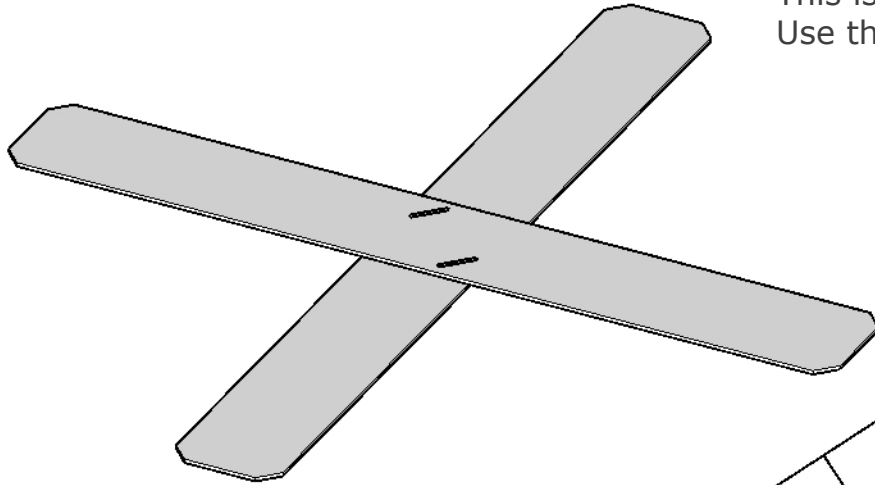

Materials Needed!

- Cereal box or other of same thickness
- Scissors
- Magic Marker or other type
- Stapler (or tape)

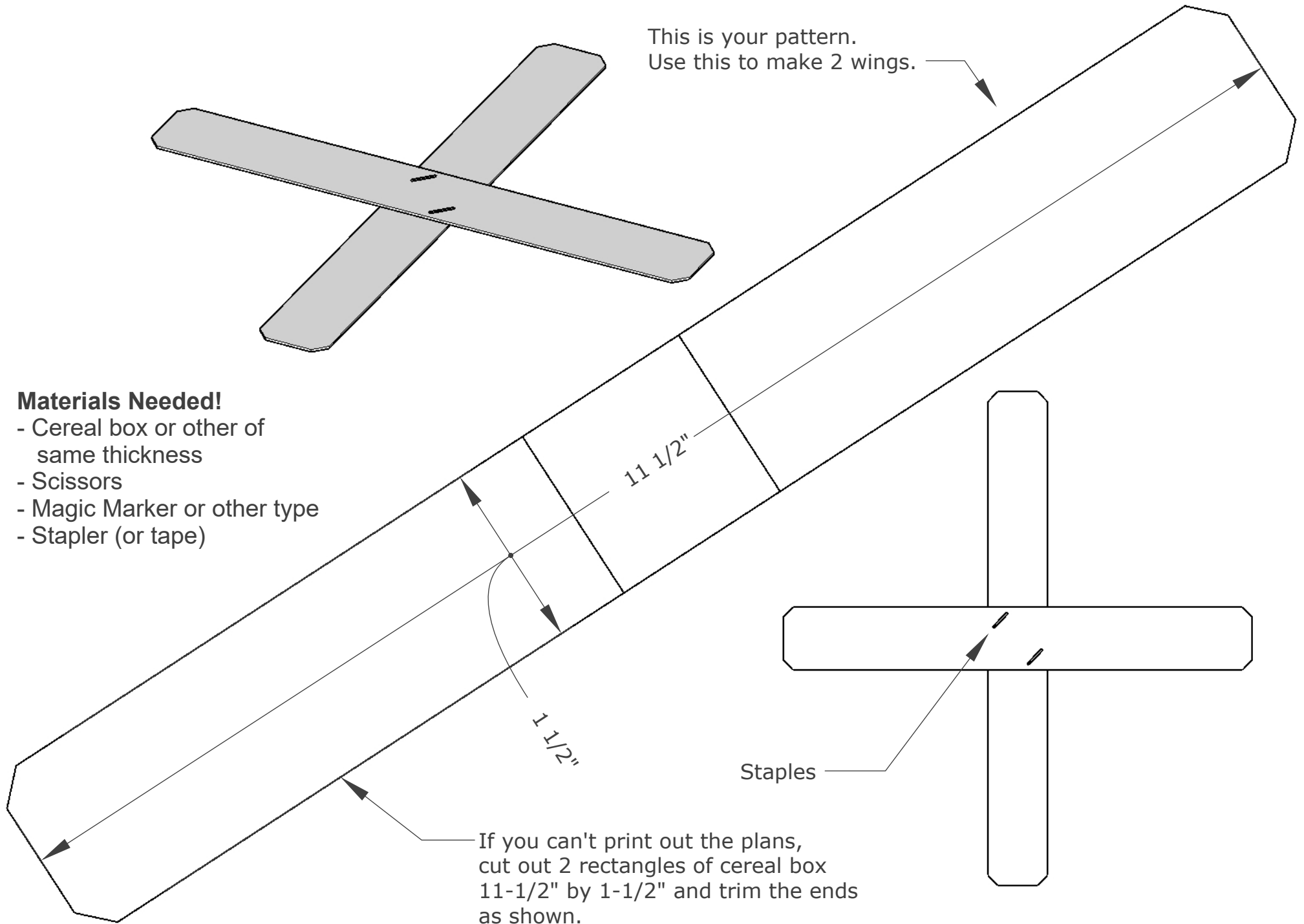

If you can't print out the plans,
cut out 2 rectangles of cereal box
11-1/2" by 1-1/2" and trim the ends
as shown.



